

EINBAUANLEITUNG KLAPPTISCH

für Gerätehaus „Europa“, „AvantGarde“, „HighLine“ und „Panorama“

- Ⓜ GB Assembly manual for the folding table for the garden shed “Europa”, “AvantGarde”, “HighLine” and “Panorama”
- Ⓜ FR Notice de montage du table pliante pour les abris de jardin “Europa”, “AvantGarde”, “HighLine” et “Panorama”
- Ⓜ NL Opbouwbeschrijving Klaptafel voor berging “Europa”, “AvantGarde”, “HighLine” en “Panorama”
- Ⓜ ES Instrucciones de montaje de la mesa plegable para las casetas «Europa», «AvantGarde», «HighLine» y «Panorama»
- Ⓜ IT Istruzioni di montaggio per tavolo ribaltabile per le casette portattrezzi “Europa”, “AvantGarde”, “HighLine” e “Panorama”
- Ⓜ DK Monteringsvejledning “Klapbord” for redskabsskuret “Europa”, “AvantGarde”, “HighLine” og “Panorama”

For further languages please go to: www.biohort.com/downloads



QUALITÄT AUS
ÖSTERREICH

1.

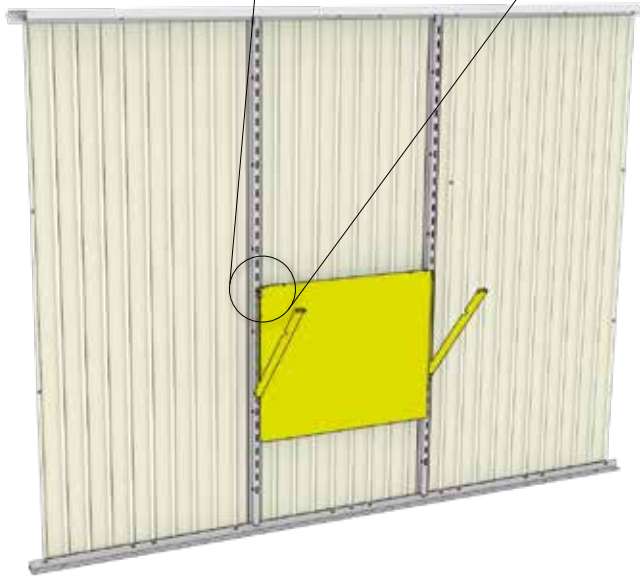
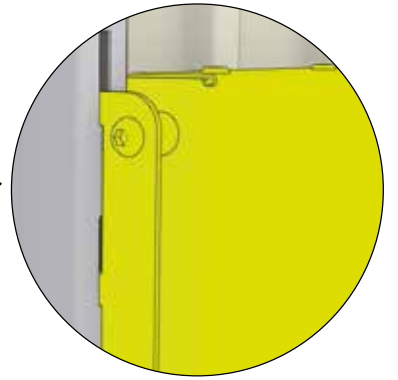
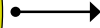
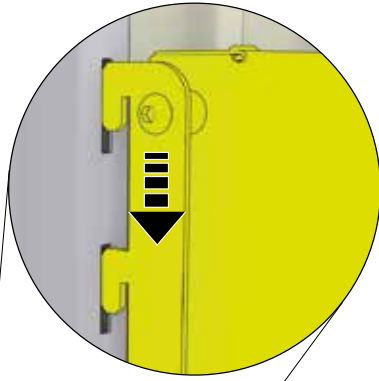
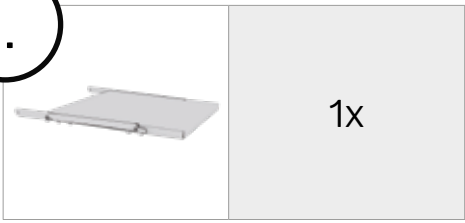

2.

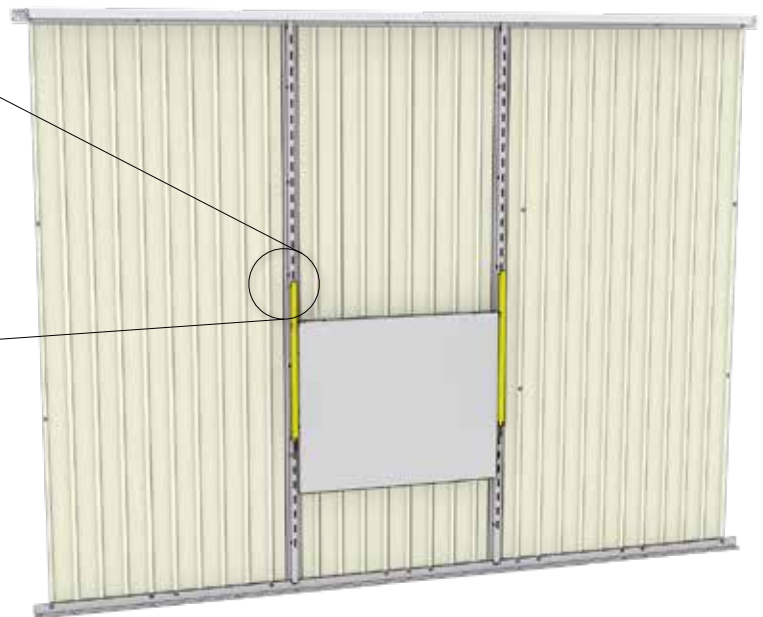
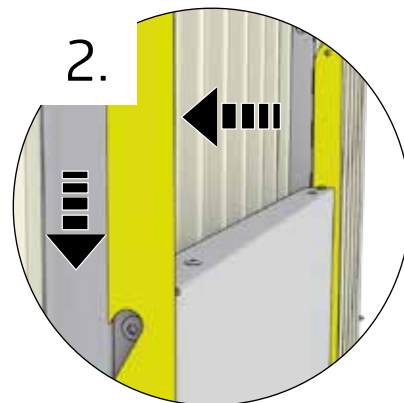
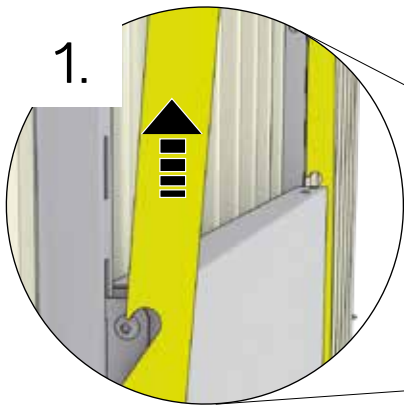

3.

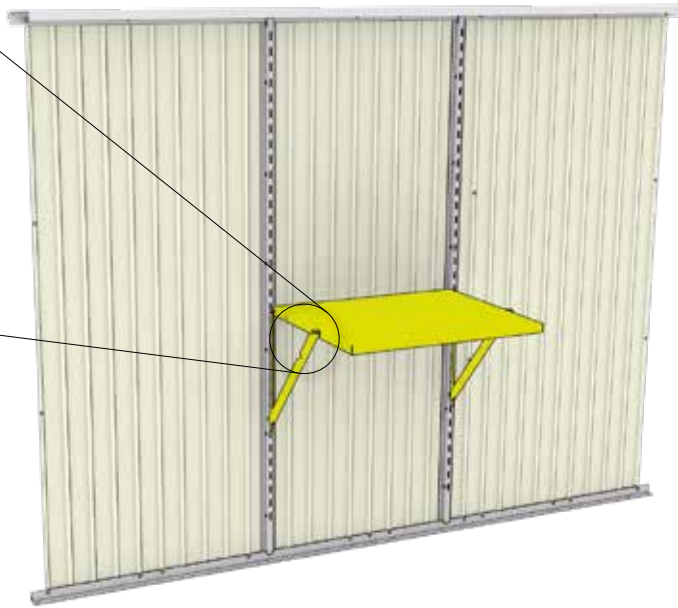
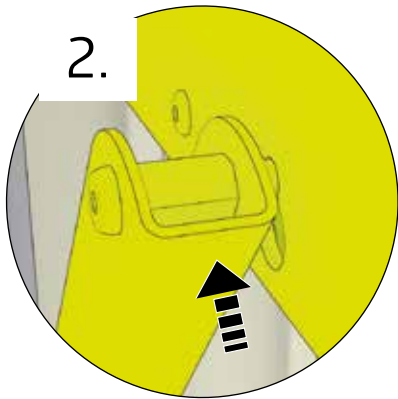
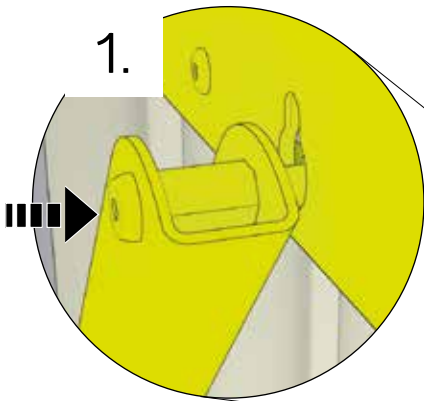

4.

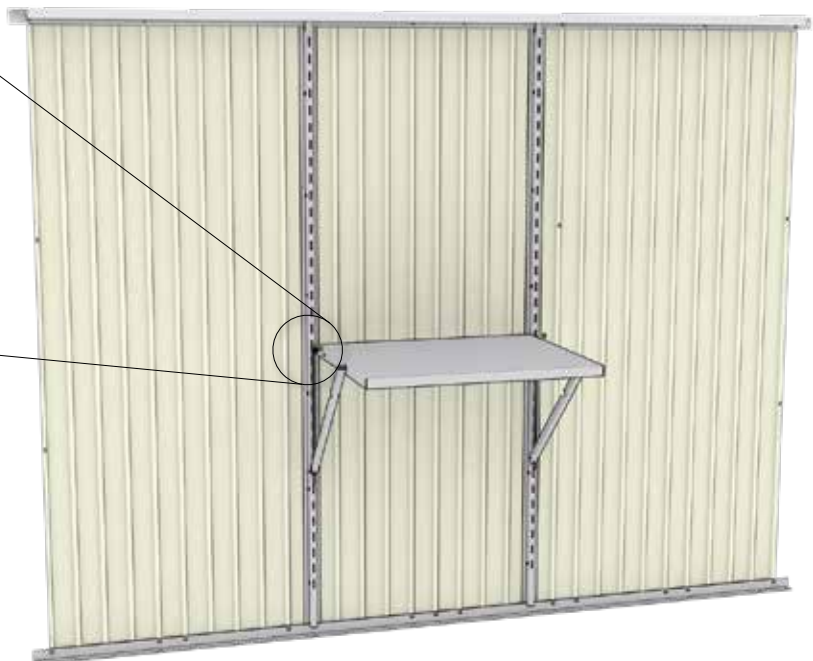
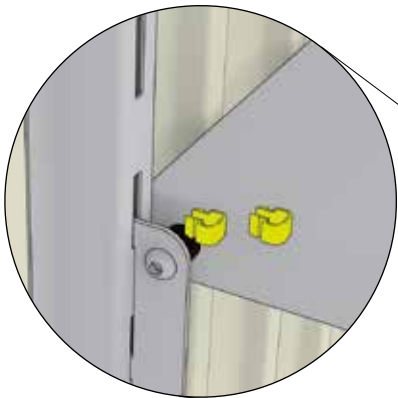
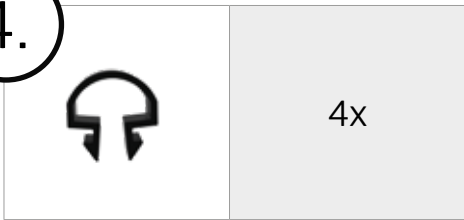



GERÄTEHÄUSER – Setzen Sie auf Qualität & Langlebigkeit
GARDEN SHEDS – rely on quality & longevity



GARTENBOXEN – Outdoorboxen für Garten, Terrasse & Co.
OUTDOOR BOXES – outdoor boxes for garden, patio & more



FAHRRAD-GARAGEN – Fahrräder, Roller & Co sicher verstaut
BICYCLE STORAGE – for safe storage of bicycles, scooters & more



MÜLLTONNEN-BOXEN – Stylish, praktisch & wartungsfrei
DUSTBIN STORAGE – stylish, practical & maintenance free



GARTEN-HELFER – Gartendesign in Bestform
GARDENING HELPERS – garden design at its best

Kontrollnummer:
 Control-number / Contrôle-Qualité / Controlnummer:



Bei Reklamationen bitte anführen:
 Kontrollnummer und Artikelnummer des reklamierten Teils.

GB: In case of complaint please indicate the control-number and the number of the item, which is subject of complaint.

F: Pour toutes réclamations: prière de joindre le numéro de contrôle et le numéro d'article de la pièce litigieuse.

NL: Bij reclamaties svp doorgeven: controlnummer en artikelnummer van het desbetreffende onderdeel.



Biohort steht für
 „LEBEN IM GARTEN“

Biohort stands for
 „LIFE IN THE GARDEN“

follow us:

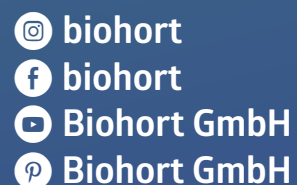

Biohort GmbH
 Pürnstein 43, 4120 Neufelden, Österreich
 Tel: +43-7282-7788-0
 E-Mail: office@biohort.at, www.biohort.com