

# S752

## uložný box

### návod na montáž / összeszerelési útmutató / instrukcje montażu

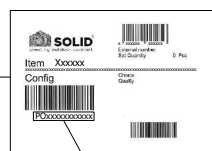
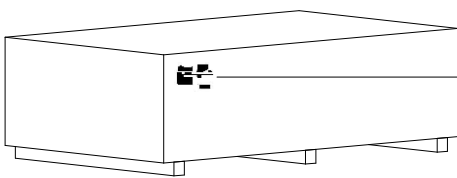

- GB Sticker
- NL Sticker
- F Autocollant
- D Aufkleber

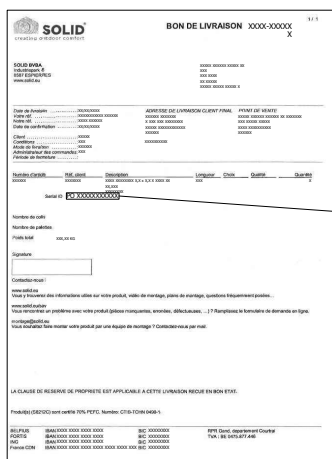

**n° PO xxxxxxxxxxxx**

- GB Delivery note
- NL Leveringsbon
- F Bon de livraison
- D Lieferbeleg

SAV / SAV / ASS / SAV / SAV / SAV

Ref.	Bruto	L	Index	#
x 00000000-000-0000-0		30000	00	00
00000000-000-0000-0		30000	00	00
x 00000000-000-0000-0		30000	00	00
x 00000000-000-0000-0		30000	00	00
x 00000000-000-0000-0		30000	00	00
x 00000000-000-0000-0		30000	00	00
x 00000000-000-0000-0		30000	00	00
x 00000000-000-0000-0		30000	00	00
x 00000000-000-0000-0		30000	00	00
x 00000000-000-0000-0		30000	00	00
x 00000000-000-0000-0		30000	00	00
x 00000000-000-0000-0		30000	00	00
x 00000000-000-0000-0		30000	00	00
x 00000000-000-0000-0		30000	00	00
x 00000000-000-0000-0		30000	00	00
x 00000000-000-0000-0		30000	00	00
x 00000000-000-0000-0		30000	00	00
x 00000000-000-0000-0		30000	00	00
x 00000000-000-0000-0		30000	00	00
x 00000000-000-0000-0		30000	00	00

Xxxxxx PO XXXXXXXXXXXX

- GB After sales service
- NL Dienst na verkoop
- F Service après vente
- D Kundendienst

# S752

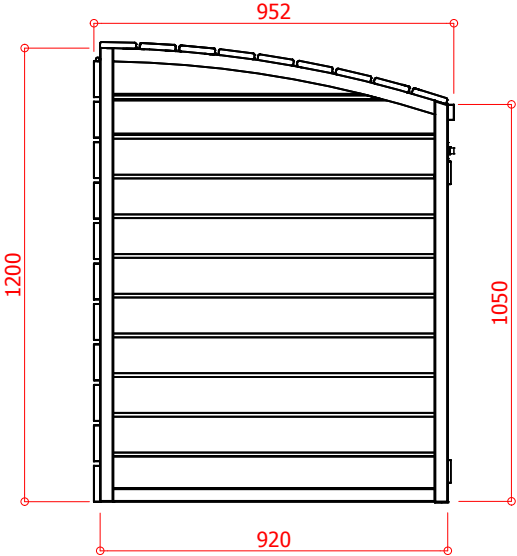
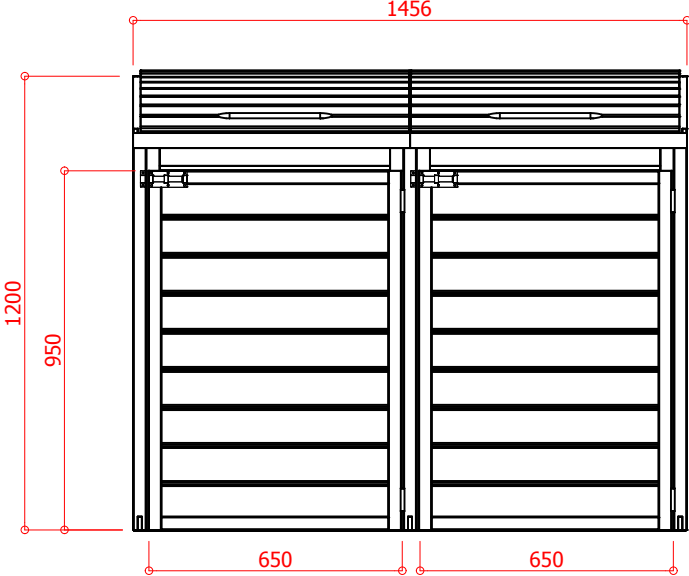







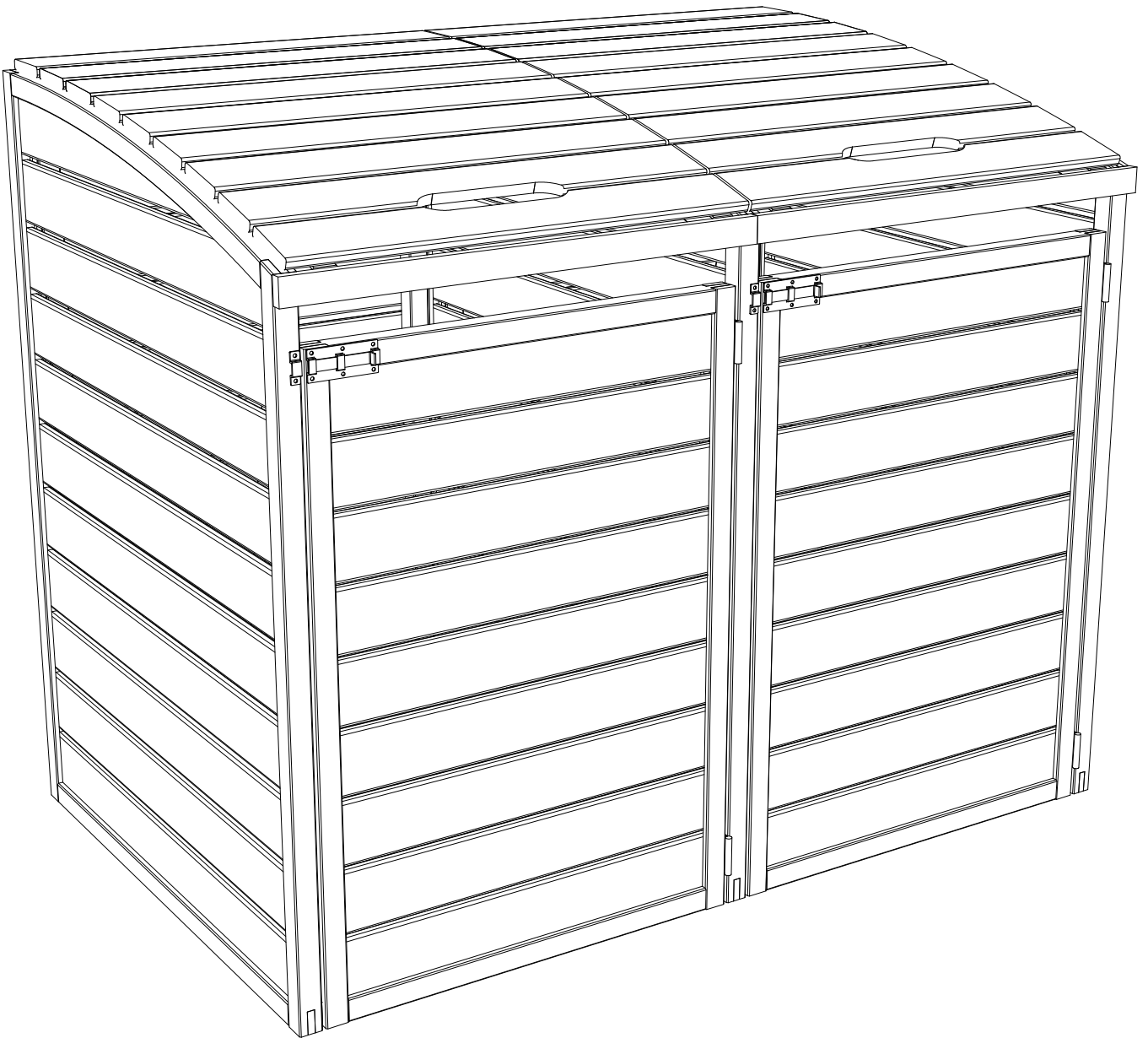



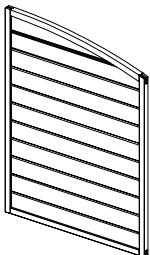
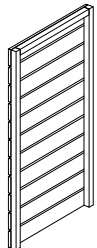
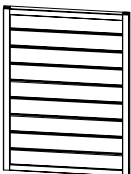
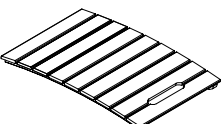

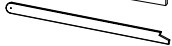
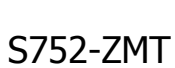
Schaal / Échelle / Scale / Escala / Escala / Scala : 1:20

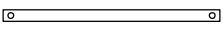

**S752**



5 412025 007523

	Ref.	Bruto	L	Index	#
	A	S752-A		3	
	B	S752-B		2	
	C	S752-C		2	
	D	S752-D		2	
	E	S752-E		2	
	F	S752-F		2	
		#4			
		#2			
		#2			
		4.0 x 70 #12			
		3.0 x 30 #40			
		3.0 x 40 #16			
		4.0 x 45 #2			
		Ø 4.0 FE #2			
		M8 x 65 #4			
		Ø 8.0 FE #4			
		Ø 8.0 PA #4			

## S752

## PO \_\_\_\_\_

Winkel / Magasin / Store / :

Klant / Cliënt / Client / :  
Adres:

Verantwoordelijke / Responsable



# S752

A = 3 | 4.0 x 70 #12  
 B = 2

1

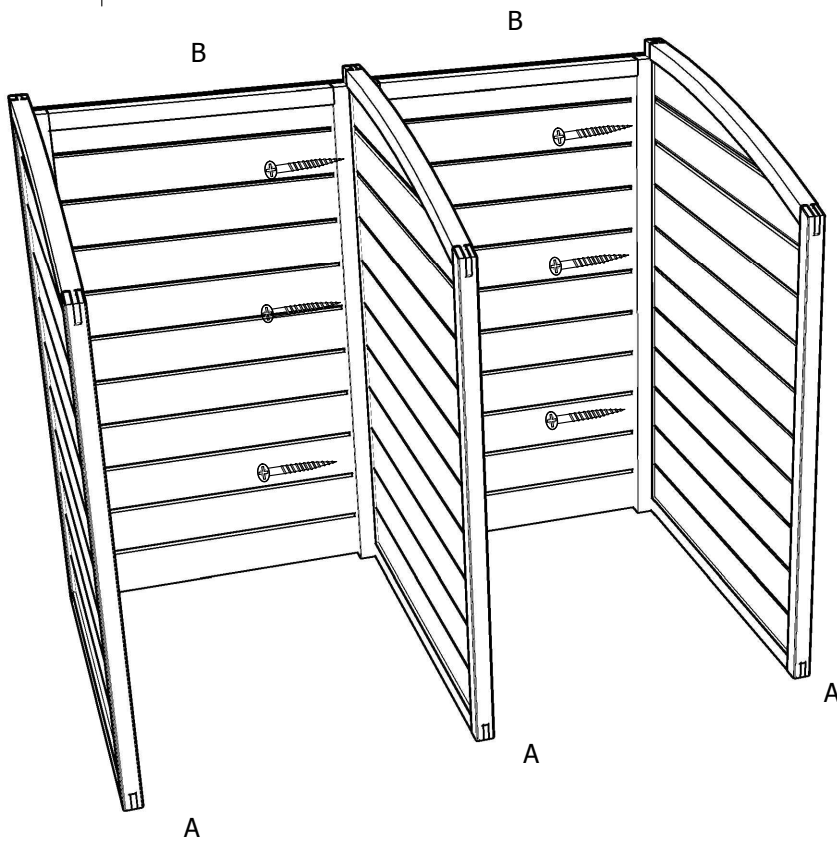

E = 2  
 #2  
 3.0 x 40 #16

D = 2  
 M8 x 65 #4  
 Ø8 FE #4  
 Ø8 PA #4

2

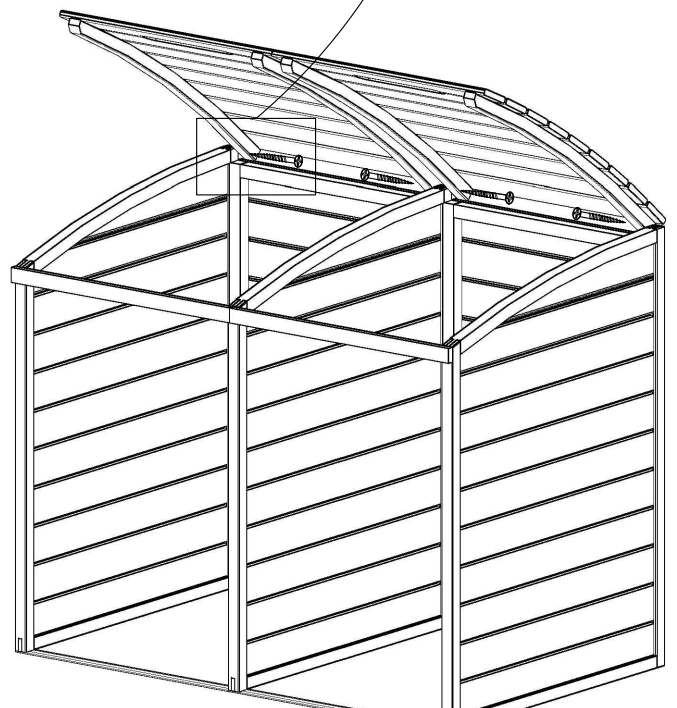
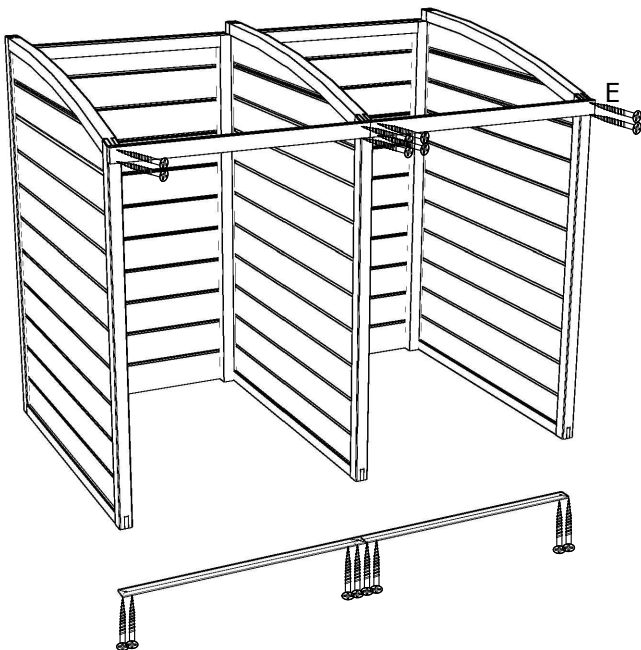

# S752

C = 2  
F = 2

3.0x30 #40

4.0 x 45 #2

Ø4 FE #2

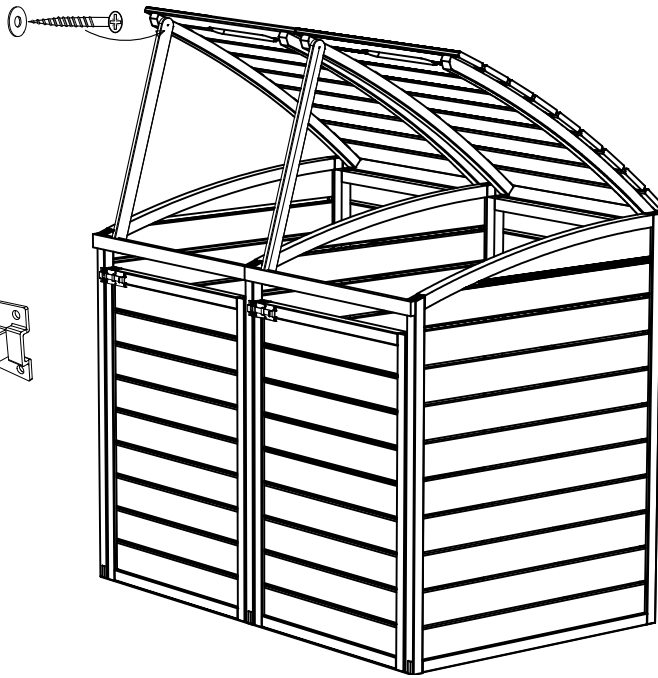
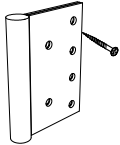
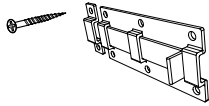

3

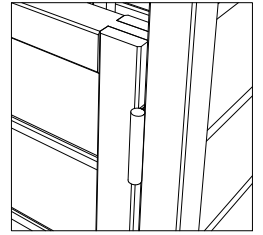
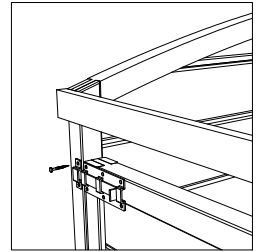

4

