

S751

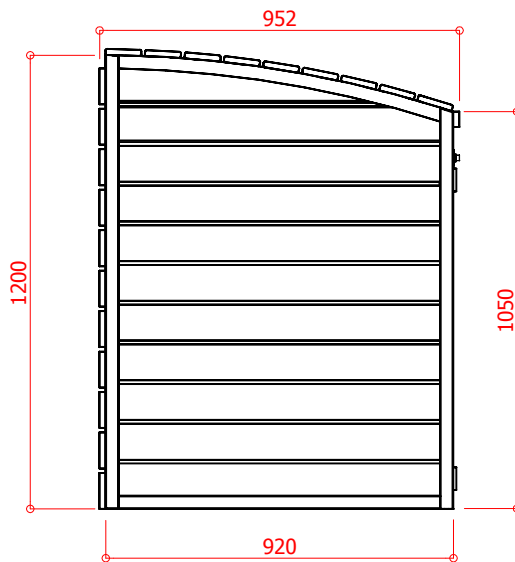

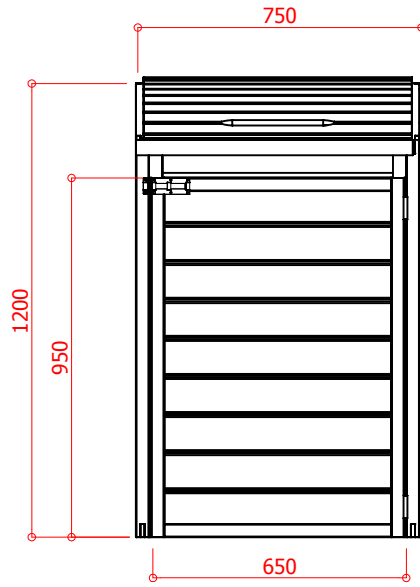









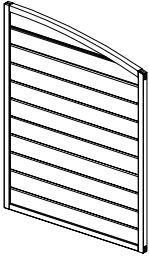
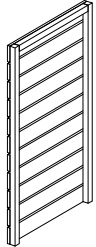
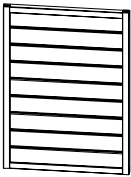
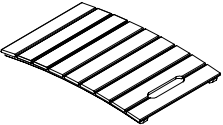

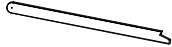
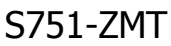
Schaal / Échelle / Scale / Escala / Escala / Scala : 1:20

S751



Industriepark 8
8587 Spiere-Helkijn

CreateDate: 24.11.2009
SaveDate: 14.03.2017
PlotDate: 14.03.2017

	Ref.	Bruto	L	Index	#
	A	S751-A		2	
	B	S751-B		1	
	C	S751-C		1	
	D	S751-D		1	
	E	S751-E		1	
	F	S751-F		1	
 S751-ZMT					#2
					#1
					#1
		4.0 x 70	#6		
		3.0 x 30	#20		
		3.0 x 40	#8		
		4.0 x 45	#1		
		Ø 4.0 FE	#1		
		M8 x 65	#2		
		Ø 8.0 FE	#2		
		Ø 8.0 PA	#2		

S751

PO _____

Winkel / Magasin / Store / :

Klant / Client / Client / :
Adres:

Verantwoordelijke / Responsable



S751

- A = 2
 B = 2
 4.0 x 70 #6

1

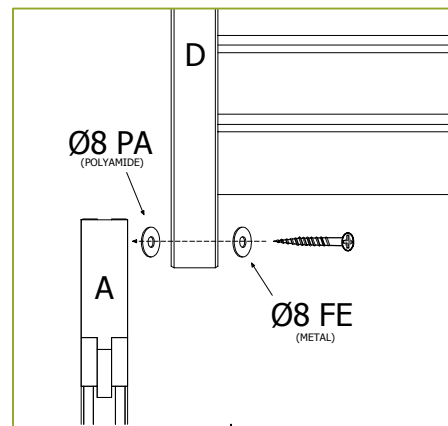
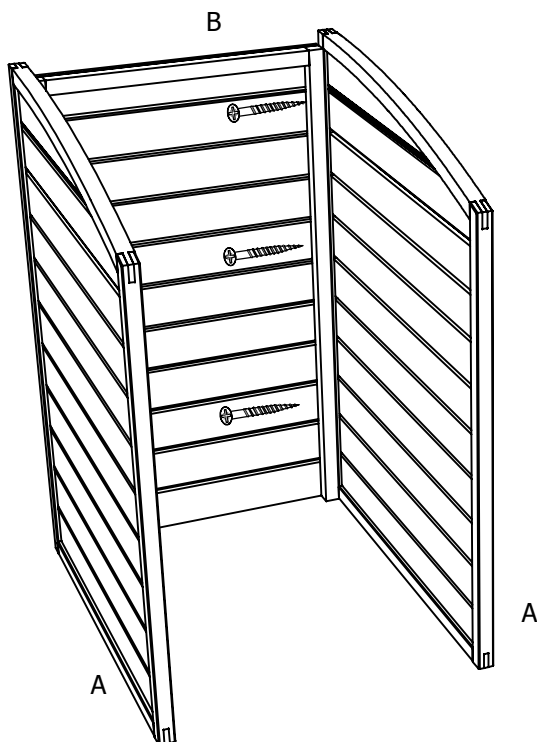

- E = 1
 #1
 3.0 x 40 #8

- D = 1
 M8 x 65 #2
 Ø8 FE #2
 Ø8 PA #2

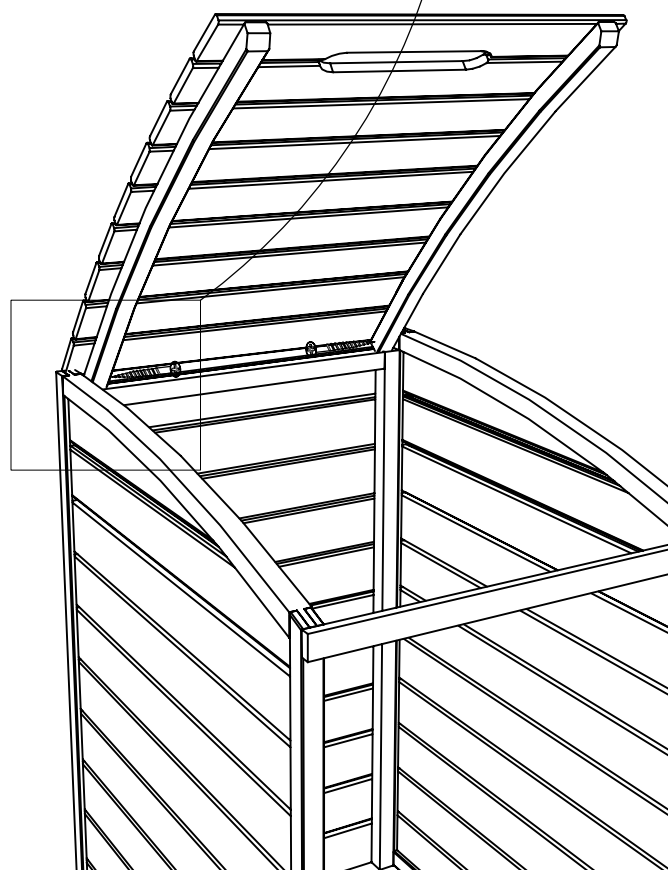

2



S751

C = 1
F = 1

 3.0 x 30 #20

 4.0 x 45 #1
 Ø4 FE #1

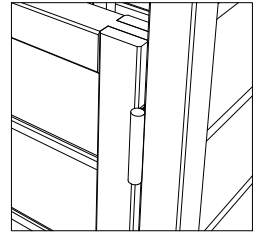
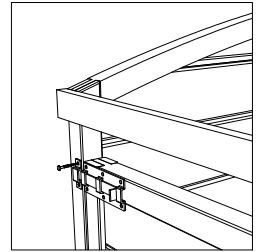
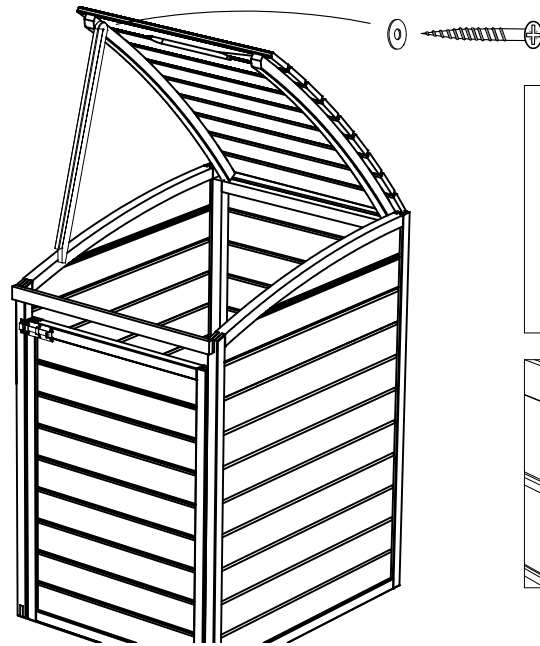
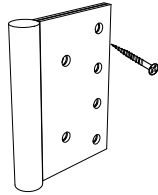
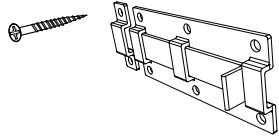

3

4

