

ALADDIN

Nr.	Title	DIMENSIONS(mm)	HEIGHT (mm)	NUMBER
1	Wood beam	28 X 40	1790	4
2	Wood shield	1790 X 1130		1
3	Wood shield	1144 X 1130		2
4	Wood shield	1790 X 1130		1
5	Floor plank	16 X 90	1144	20
6	Wood shield	1790 X 450		2
7	Door	520 X 1110		1
8	Roof plank	16 X 90	1800	24
9	Stanchion	28 X 40	1190	2
10	Lath	28 X 40	900	4
11	Wood plank	16 X 90	600	4
12	Wood plank	28 X 40	185	4
13	Roofing felt	1000 X 1800		2
14	Roofing felt	300 X 1800		1
15	Pivot			2
16	Lath	16 X 30	1040	4
17	Woody	16 X 90	1070	4
18	Rhomb			2
19	Lath	16 X 60	1090	4
a	Screw	3.5 X 35		79
b	Screw	4.0 X 70		34
c	Nail	2.6 X 40		100
d	Nail	3.0 X 20		50
e	Handle			1

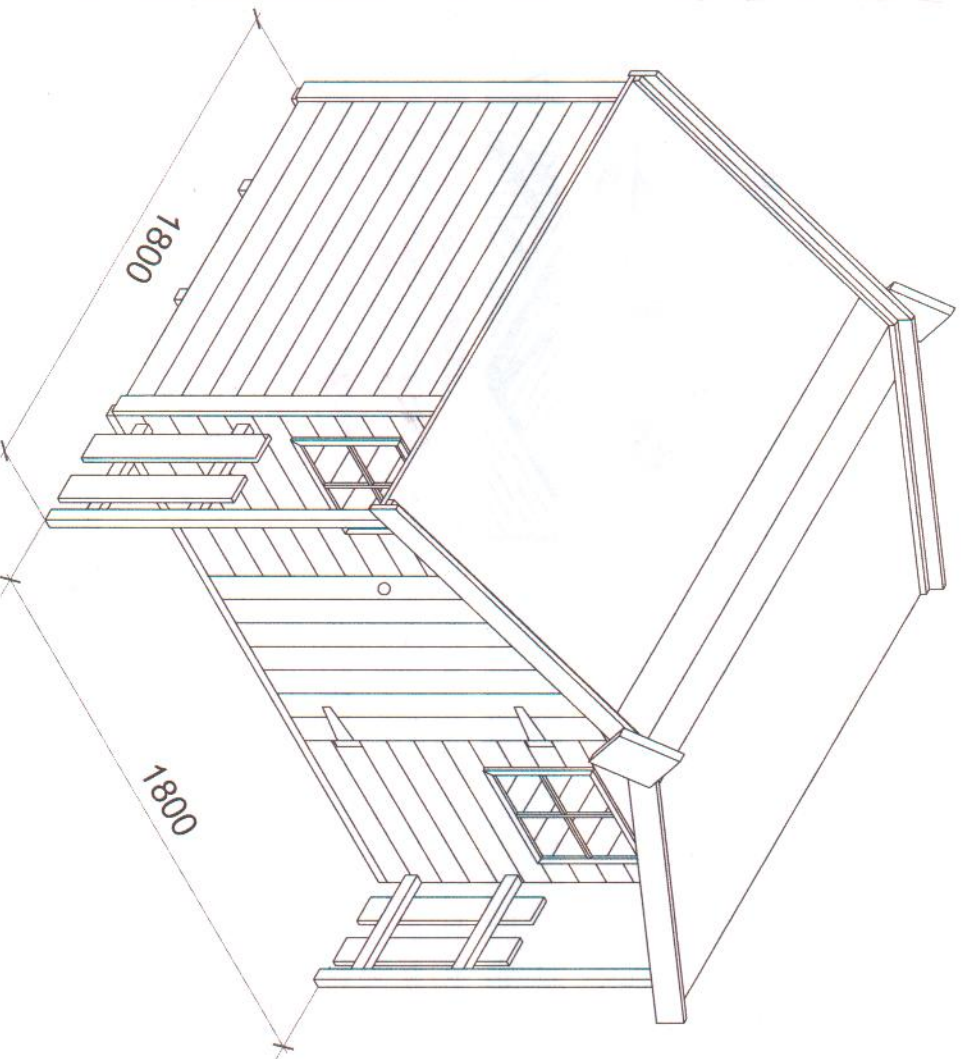

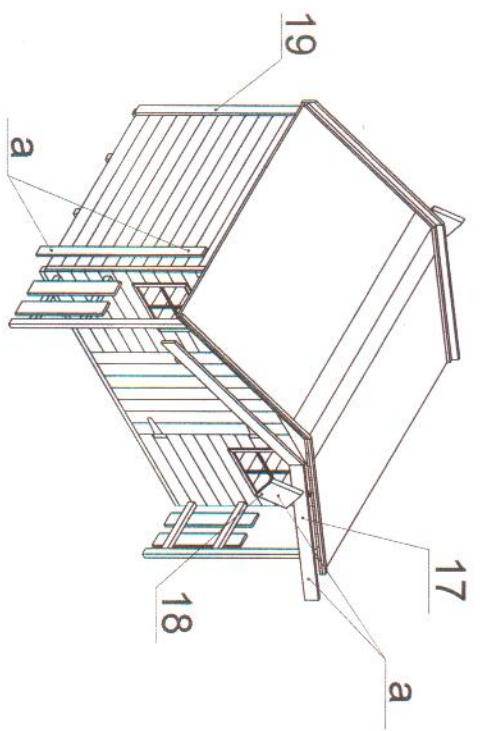

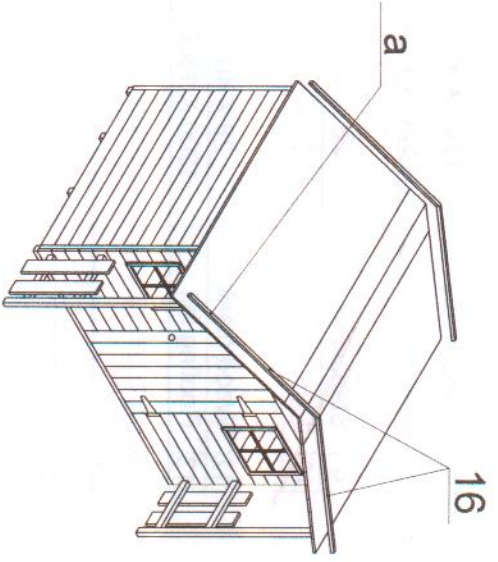
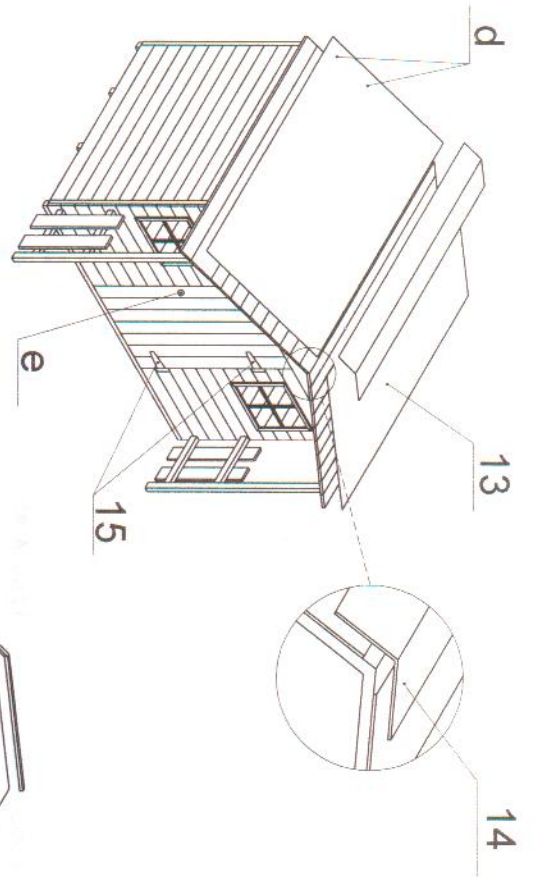
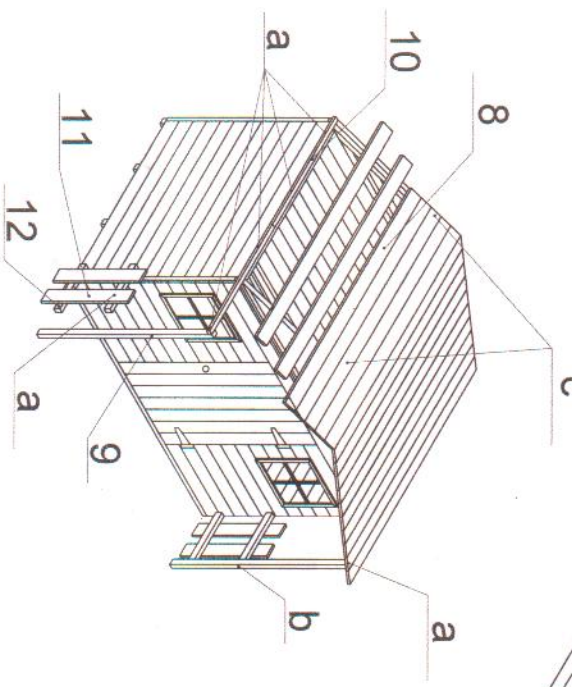
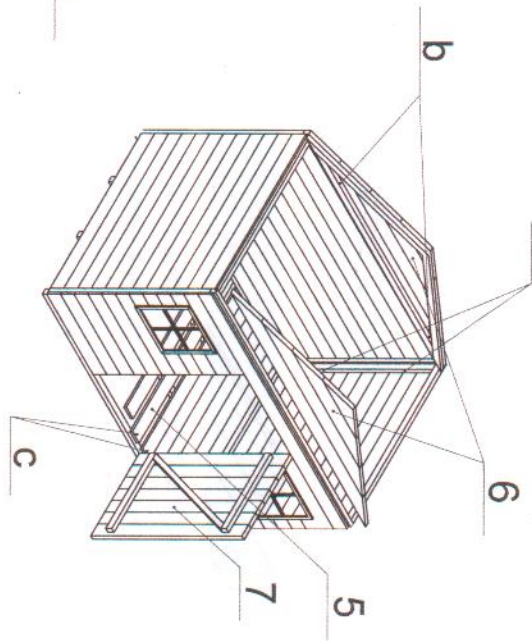
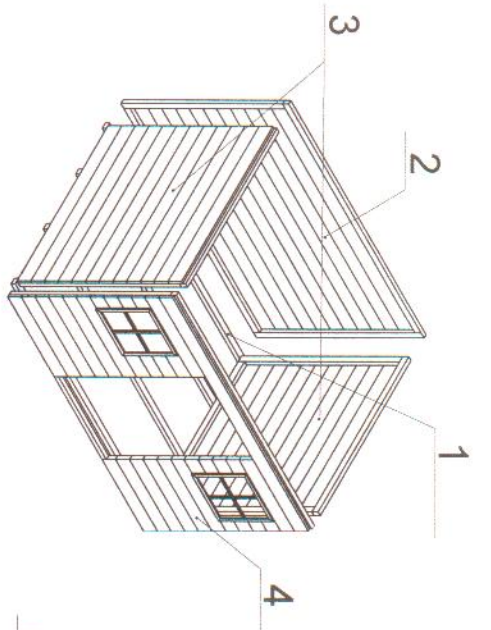
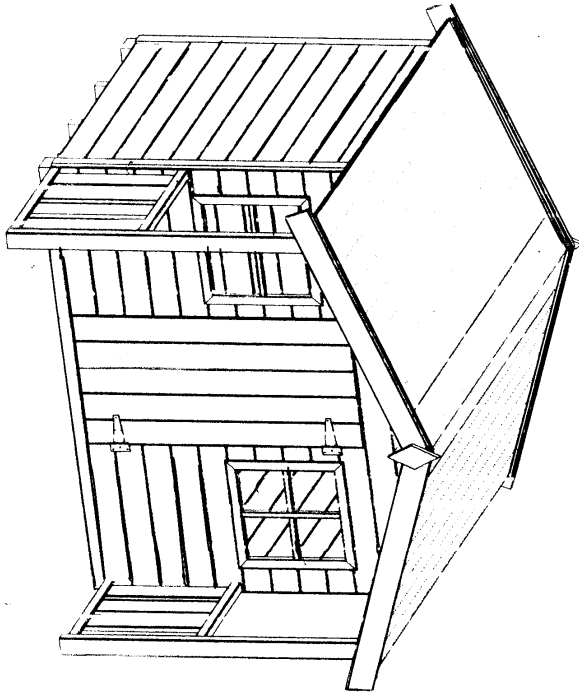
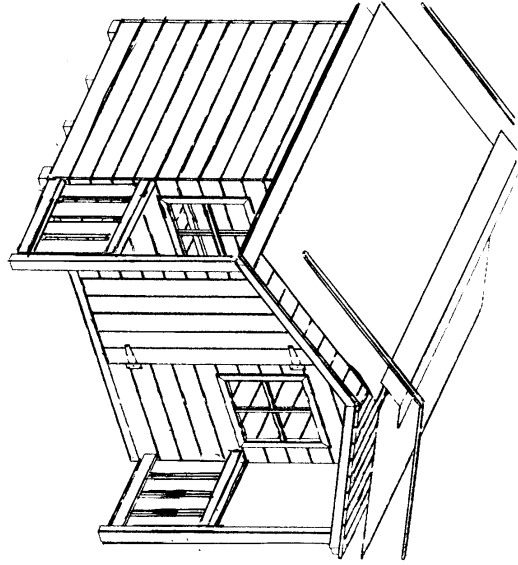
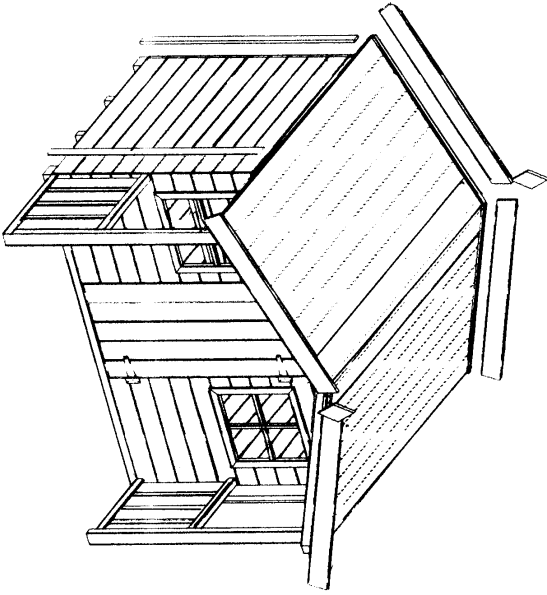

ALADDIN
4,19 m x 4,79 m x H 4,68 m

