

Chicken coop Barnevelder

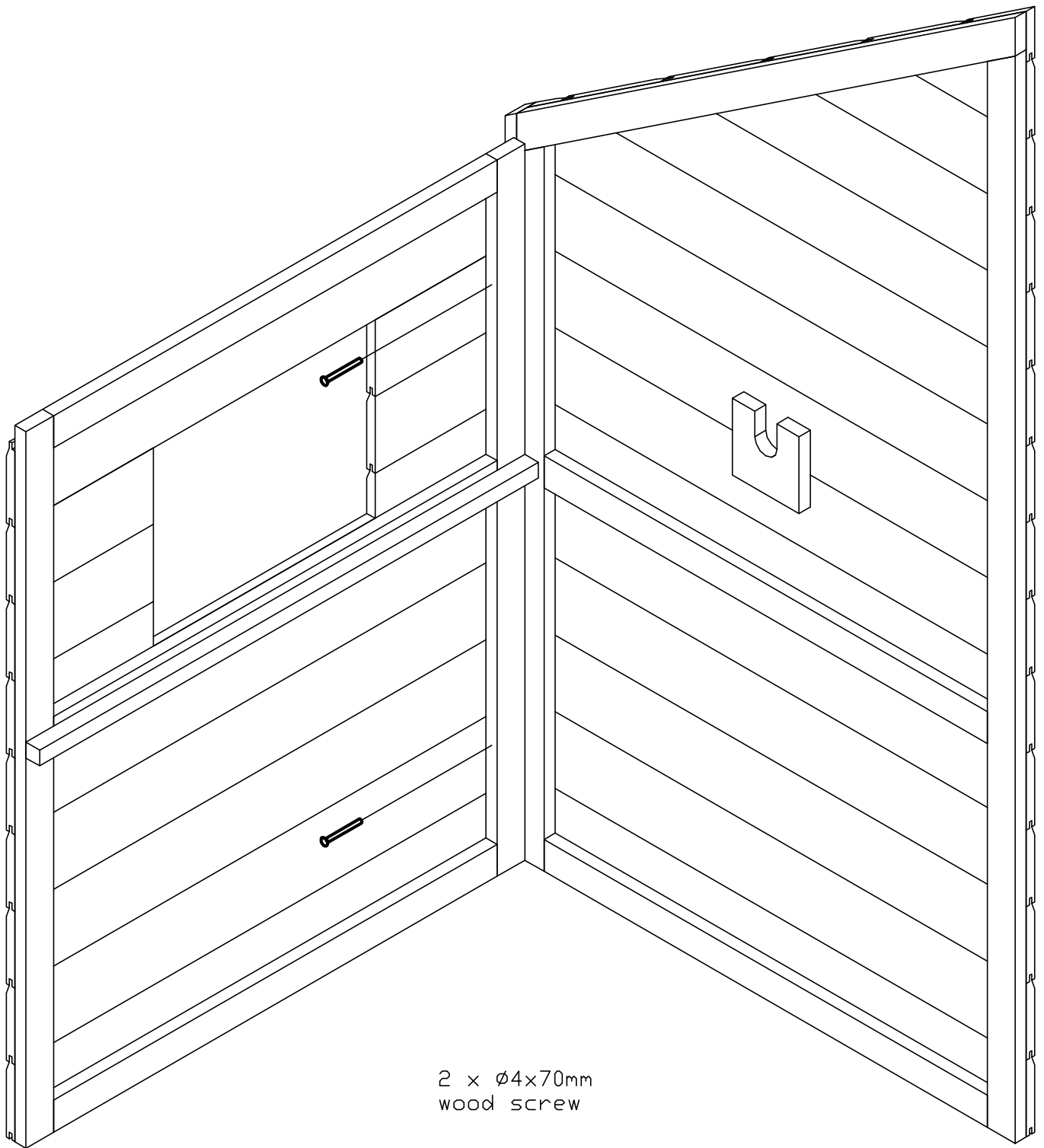

Article:

Chicken coop Barnevelder

Article nr:

26.0061

Last modified:

05.03.2011

Page:

2/11

2 x $\varnothing 4 \times 70$ mm
wood screw

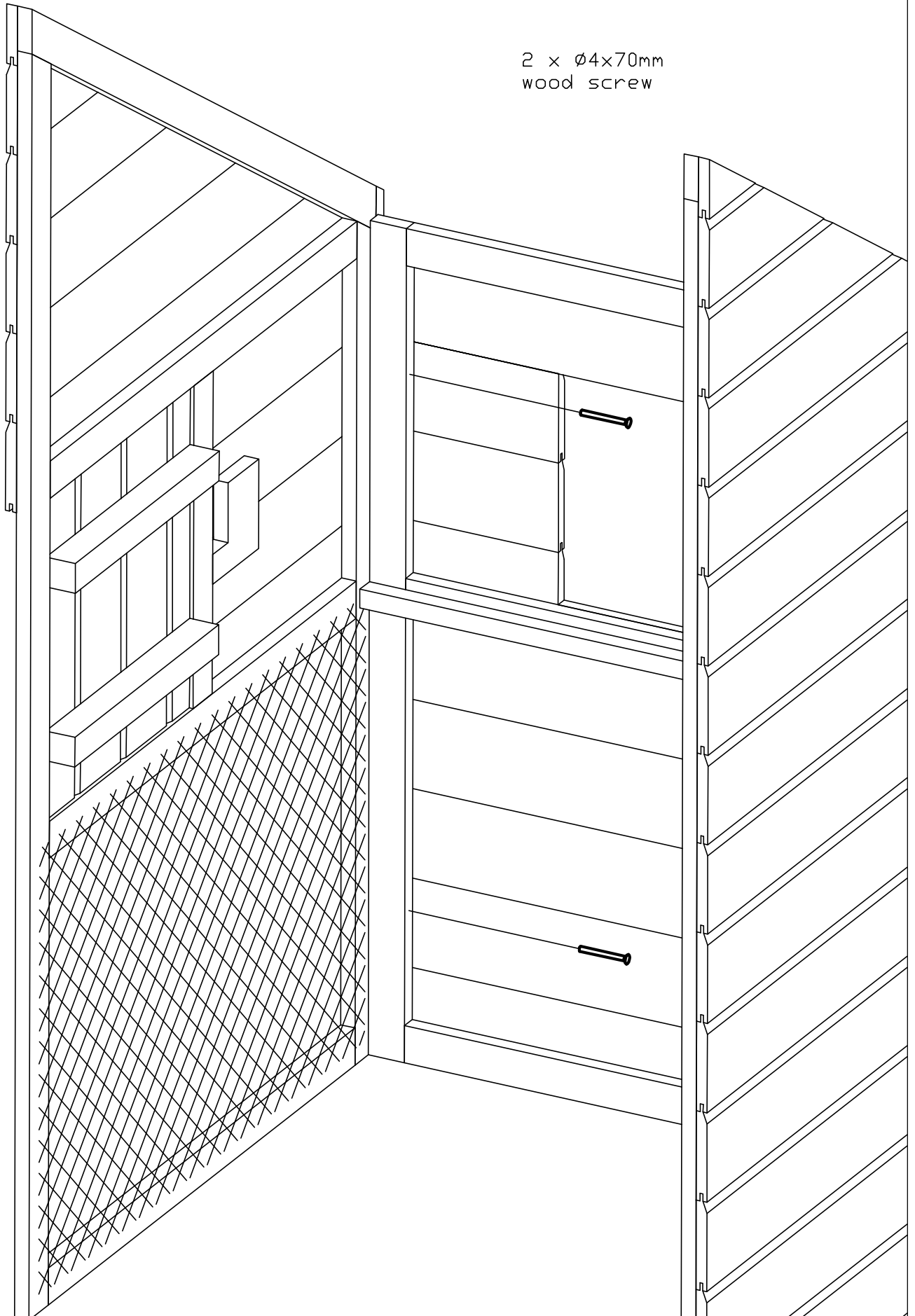

Article:

Chicken coop Barnevelder

Article nr:

26.0061

Last modified:

05.03.2011

Page:

3/11

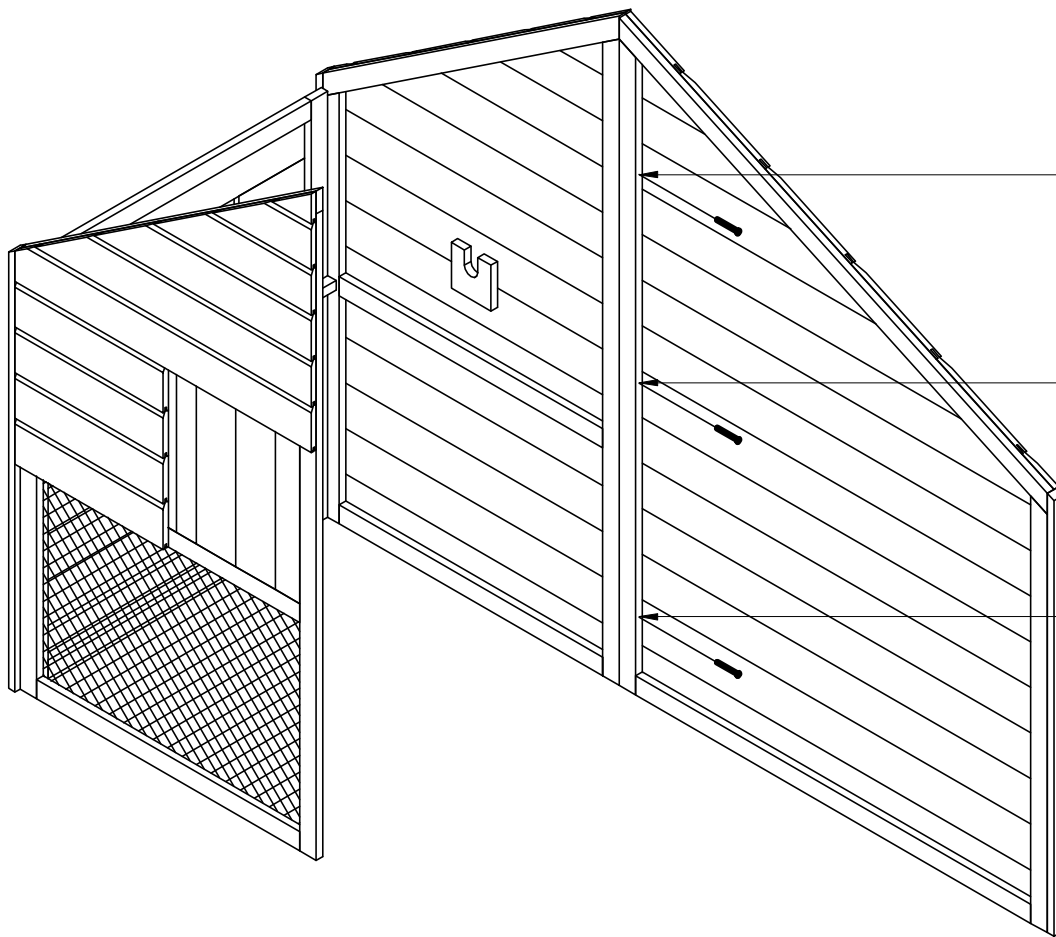

3 x \varnothing 4x70mm
wood screw

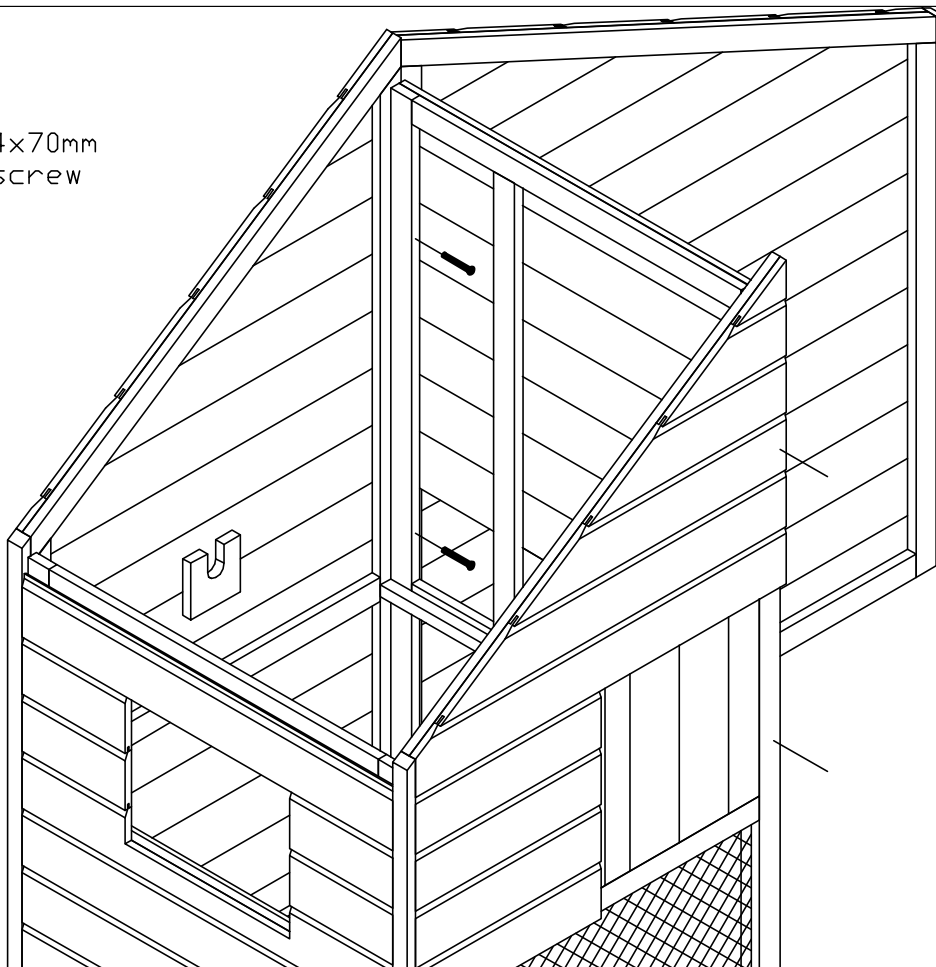

4 x \varnothing 4x70mm
wood screw

Article:

Chicken coop Barnevelder

Article nr:

26.0061

Last modified:

05.03.2011

Page:

4/11

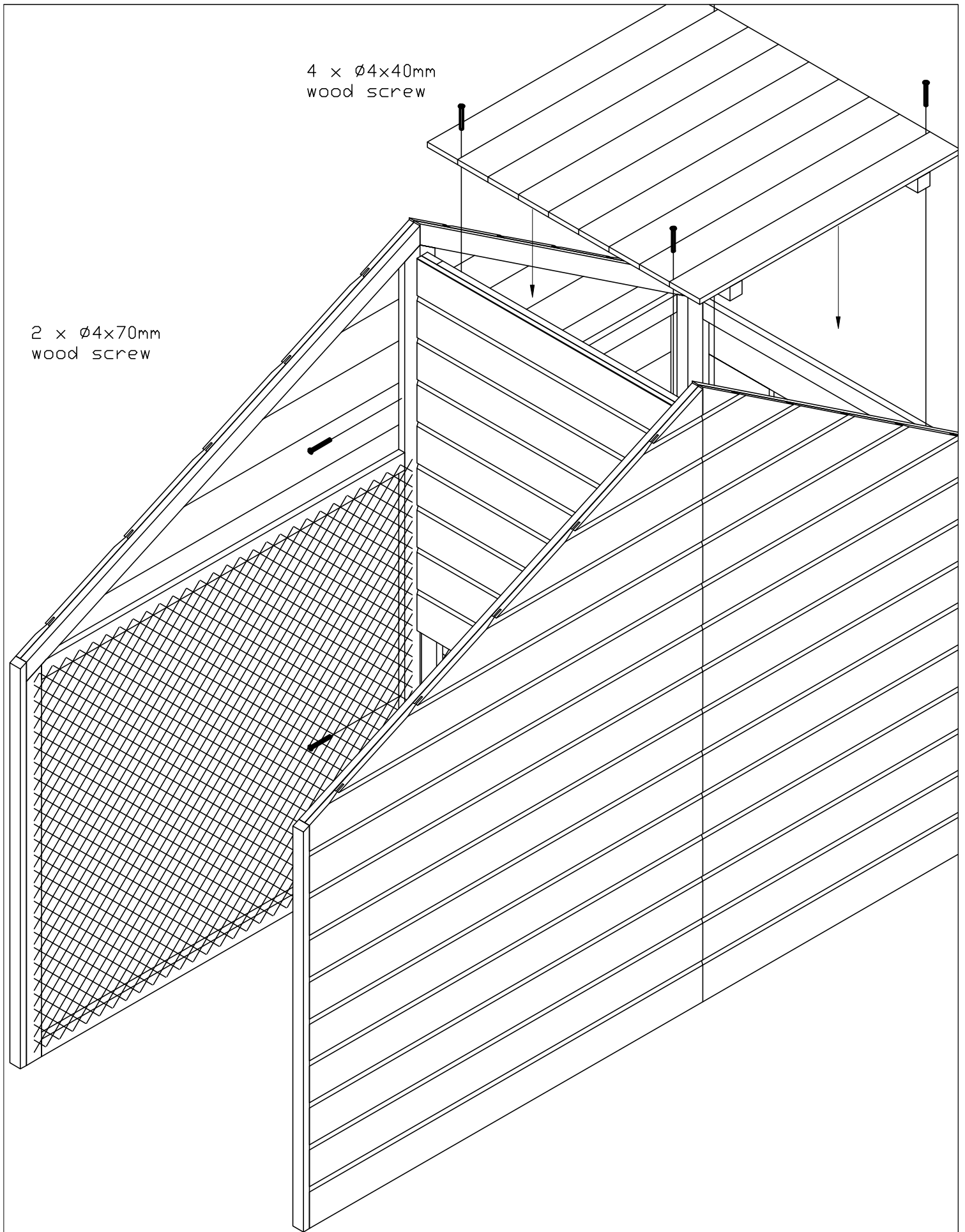

Article:

Chicken coop Barnevelder

Article nr:

26.0061

Last modified:

05.03.2011

Page:

5/11

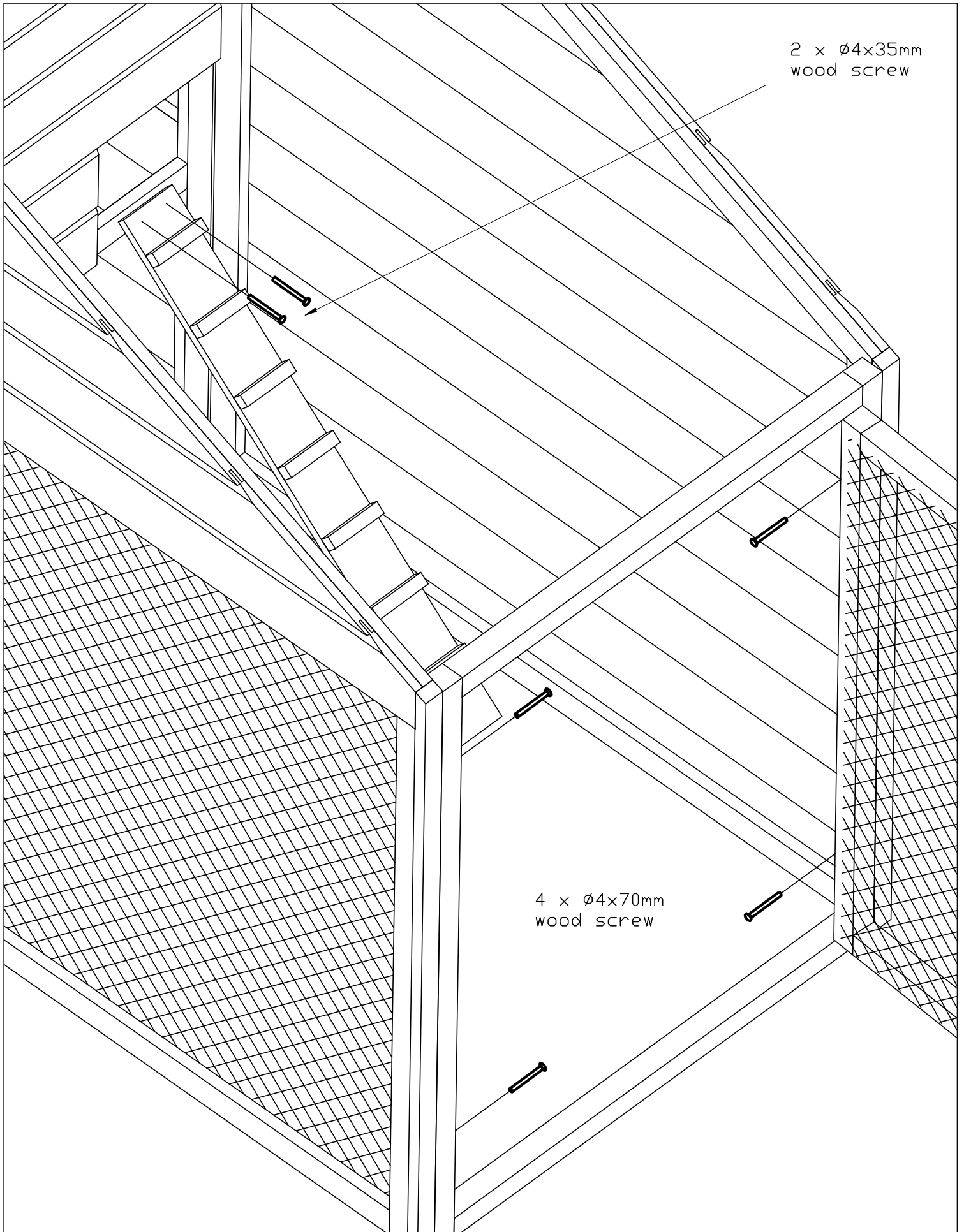

2 x Ø4x35mm
wood screw

4 x Ø4x70mm
wood screw

Article:

Chicken coop Barnevelder

Article nr:

26.0061

Last modified:

05.03.2011

Page:

6/11

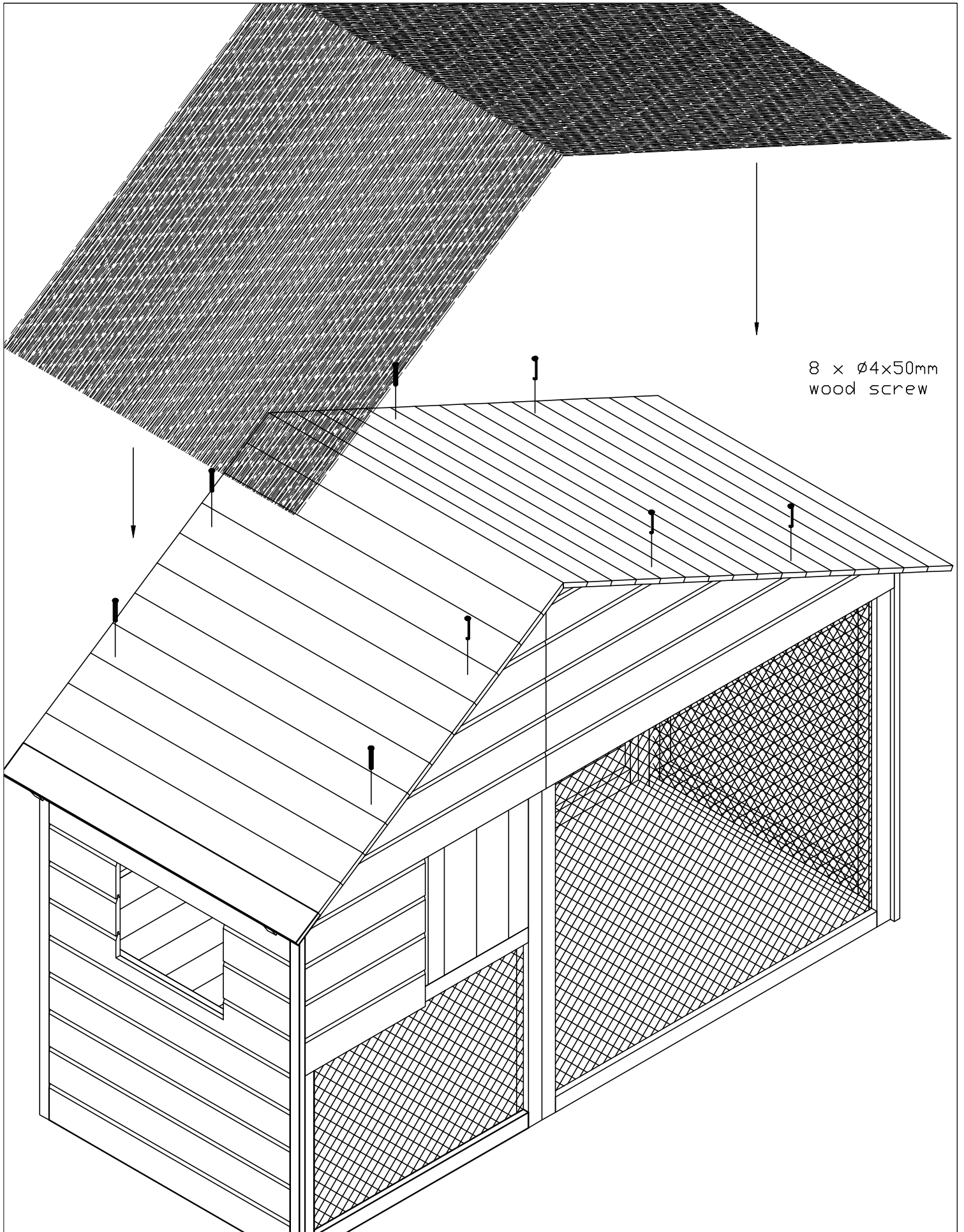

Article:

Chicken coop Barnevelder

Article nr:

26.0061

Last modified:

05.03.2011

Page:

7/11

9 x $\varnothing 4 \times 35$ mm
wood screw

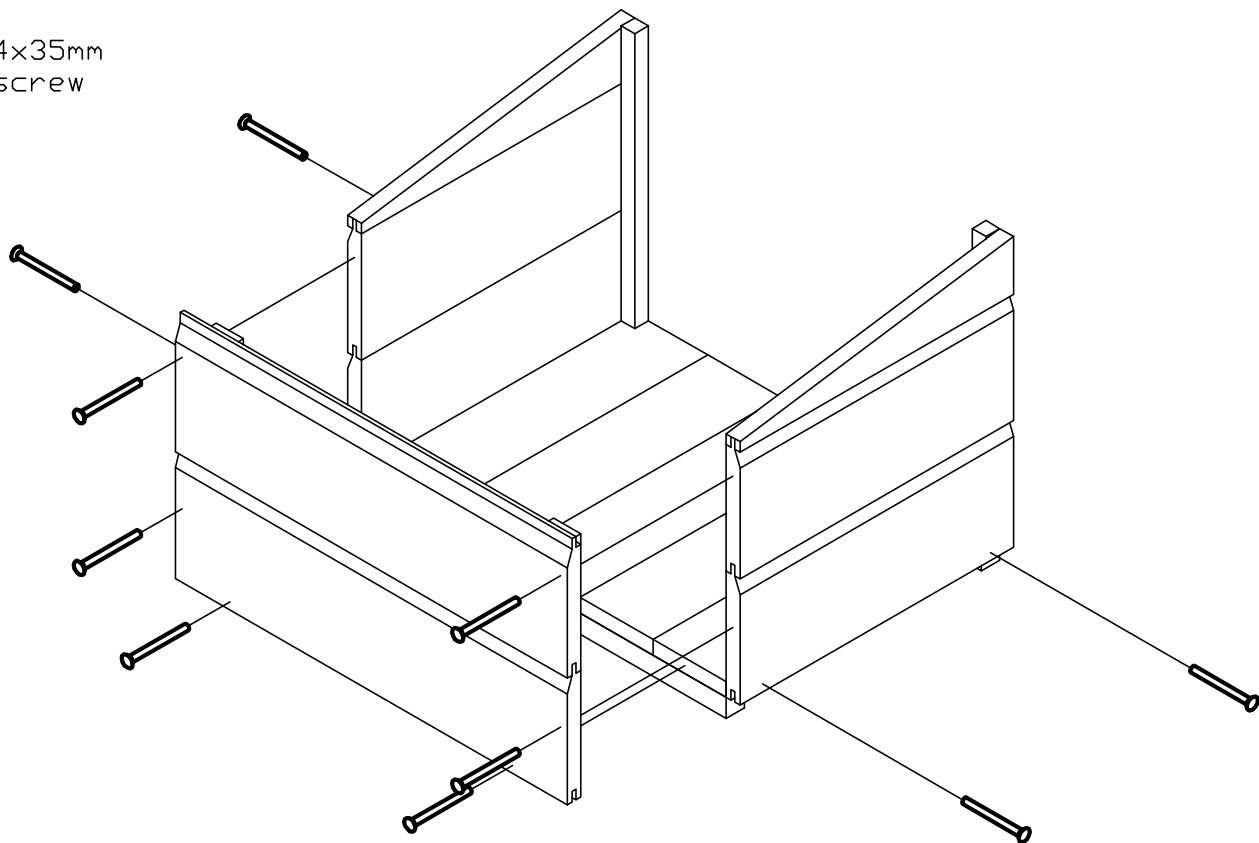

4 x $\varnothing 4 \times 35$ mm
wood screw

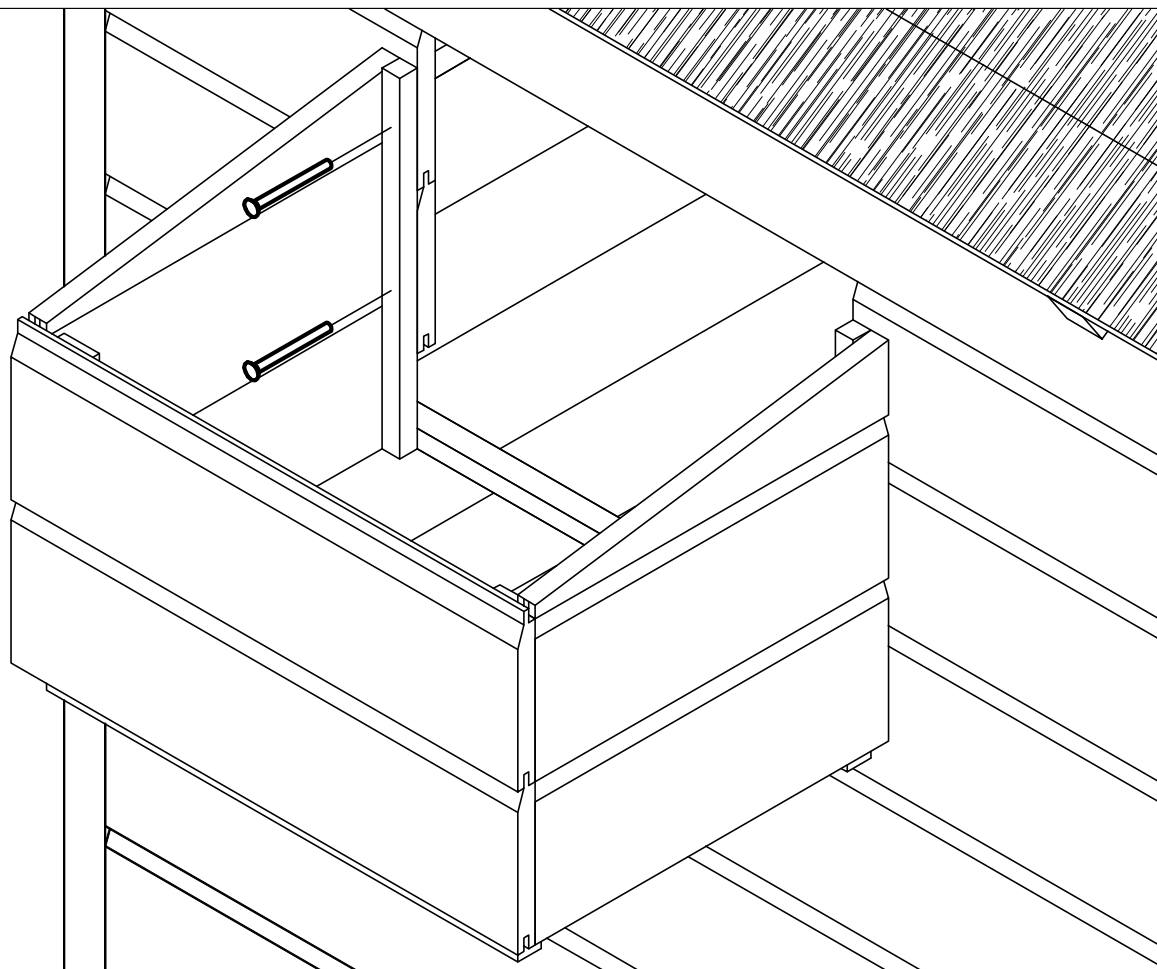

Article:

Chicken coop Barnevelder

Article nr:

26.0061

Last modified:

05.03.2011

Page:

8/11

4 x Ø4x35mm
wood screw

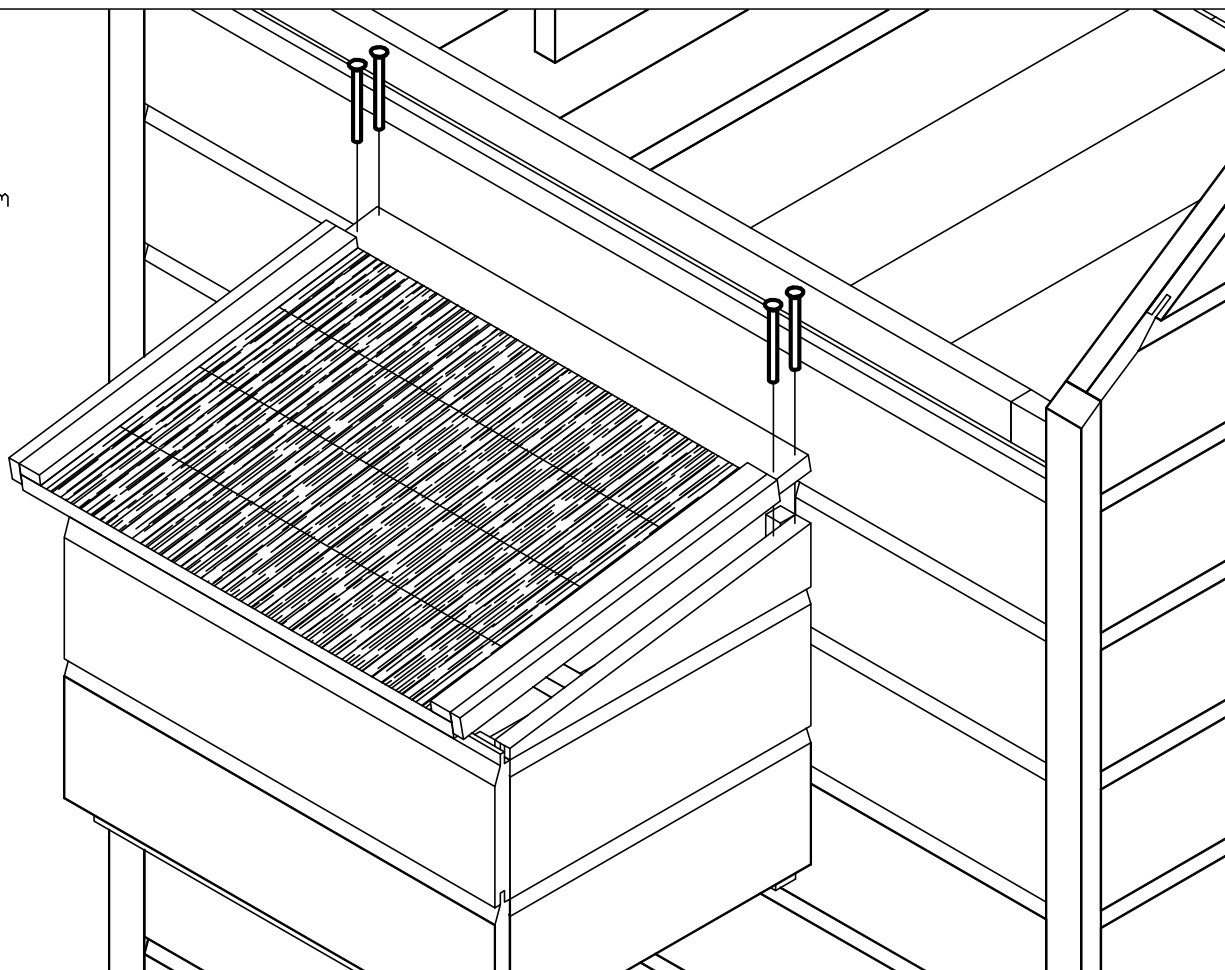

3 x Ø4x35mm
wood screw

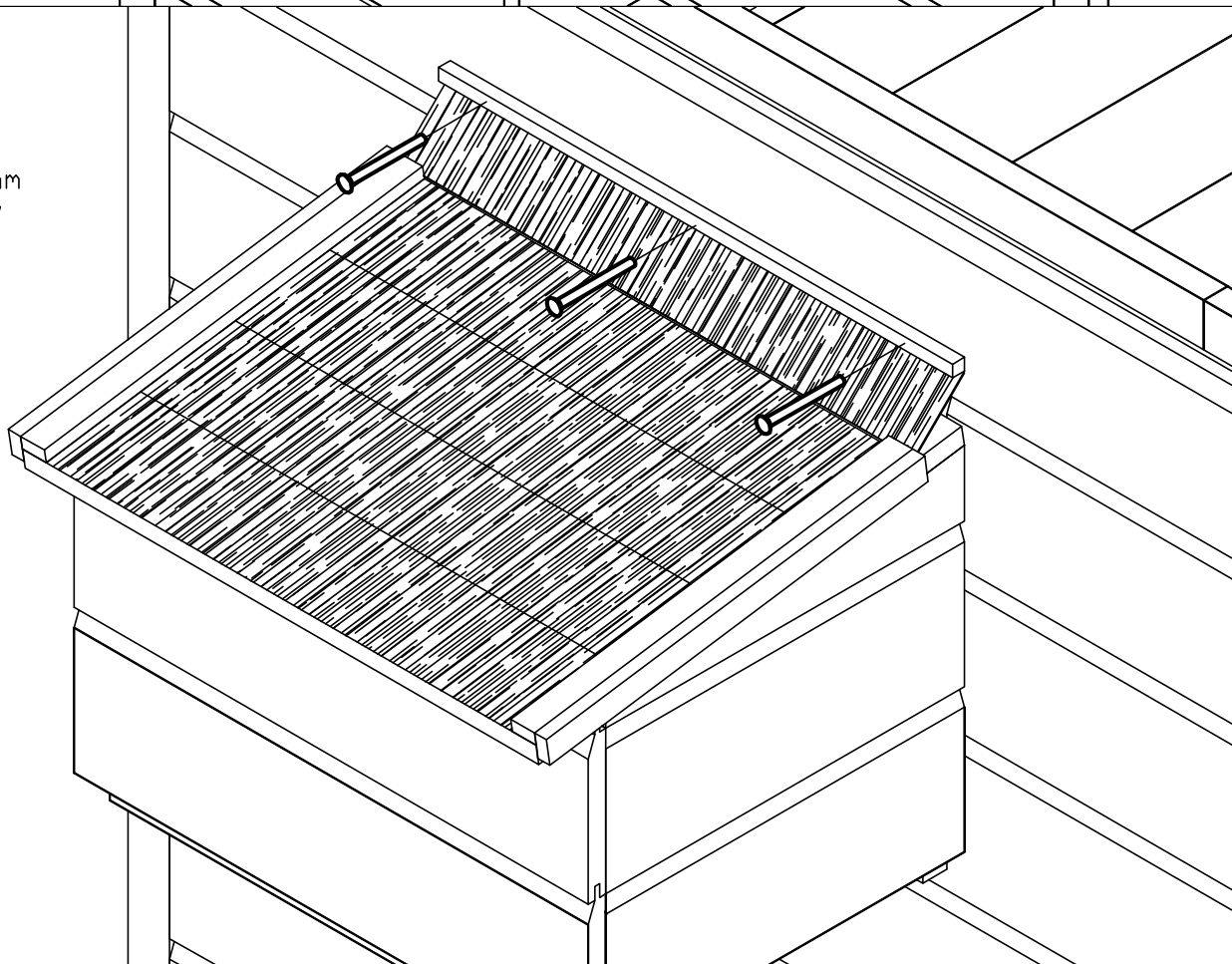

Article:

Chicken coop Barnevelder

Article nr:

26.0061

Last modified:

05.03.2011

Page:

9/11

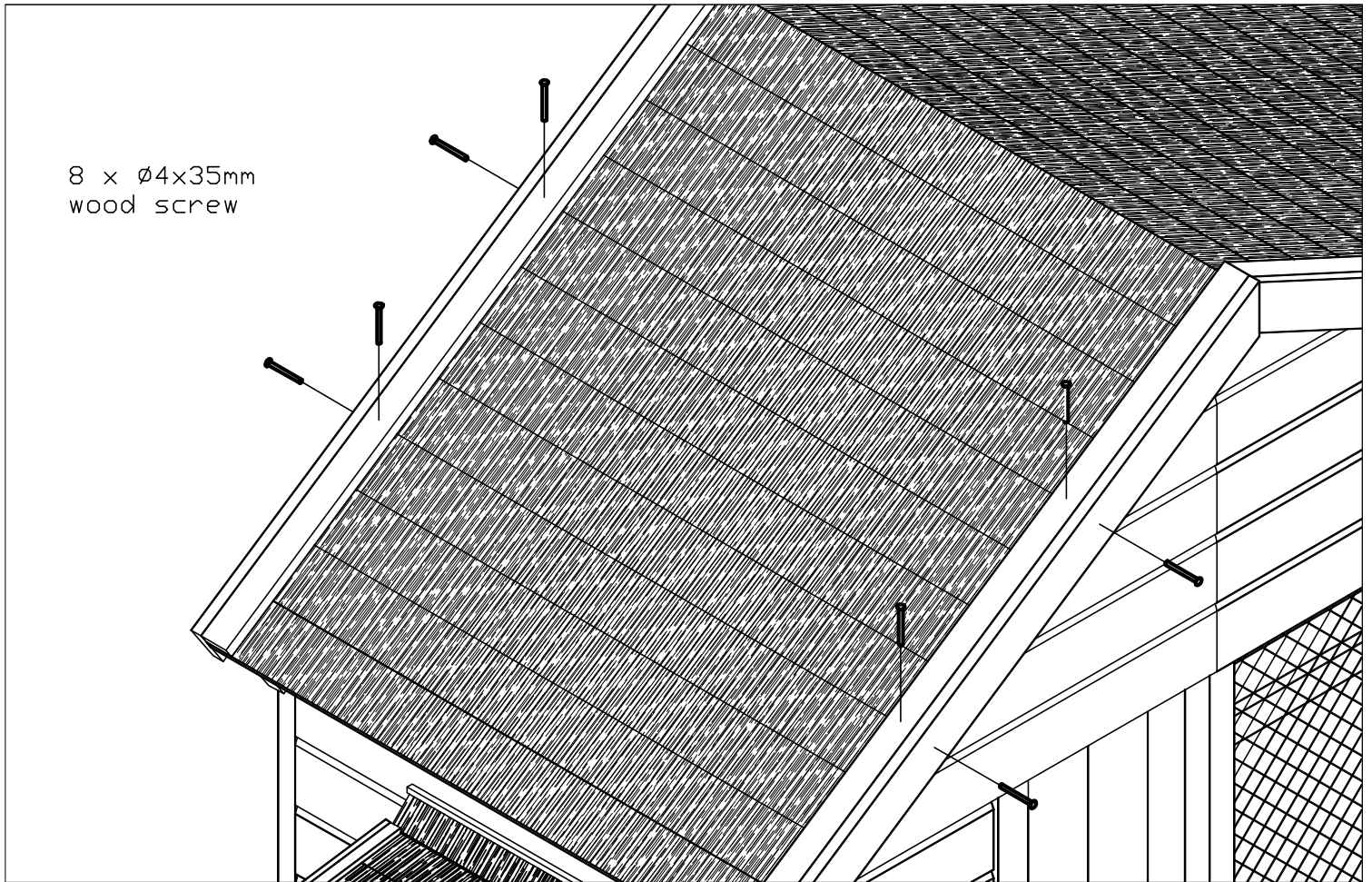

8 x Ø4x35mm
wood screw

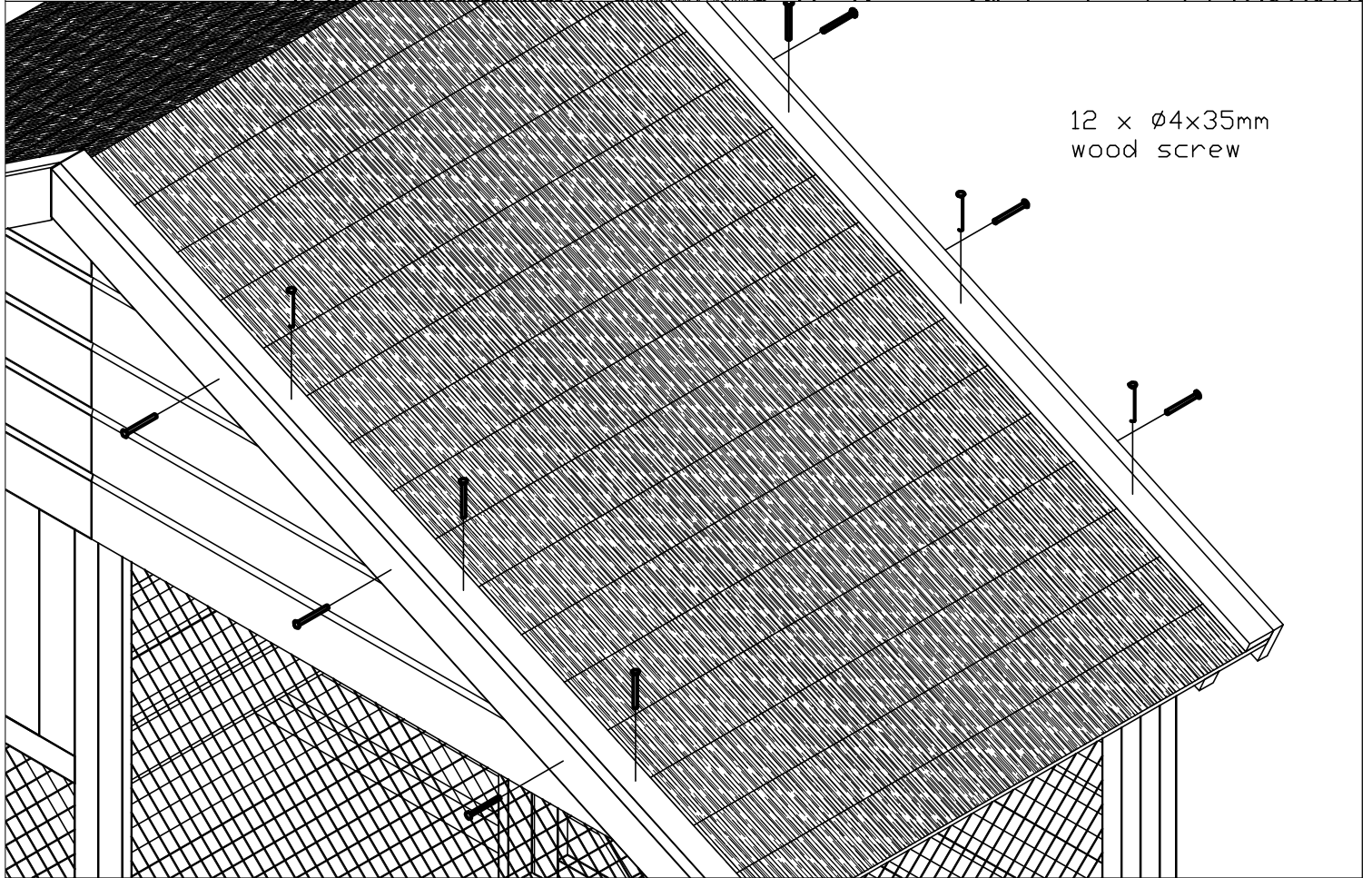

12 x Ø4x35mm
wood screw

Article:

Chicken coop Barnevelder

Article nr:

26.0061

Last modified:

05.03.2011

Page:

10/11

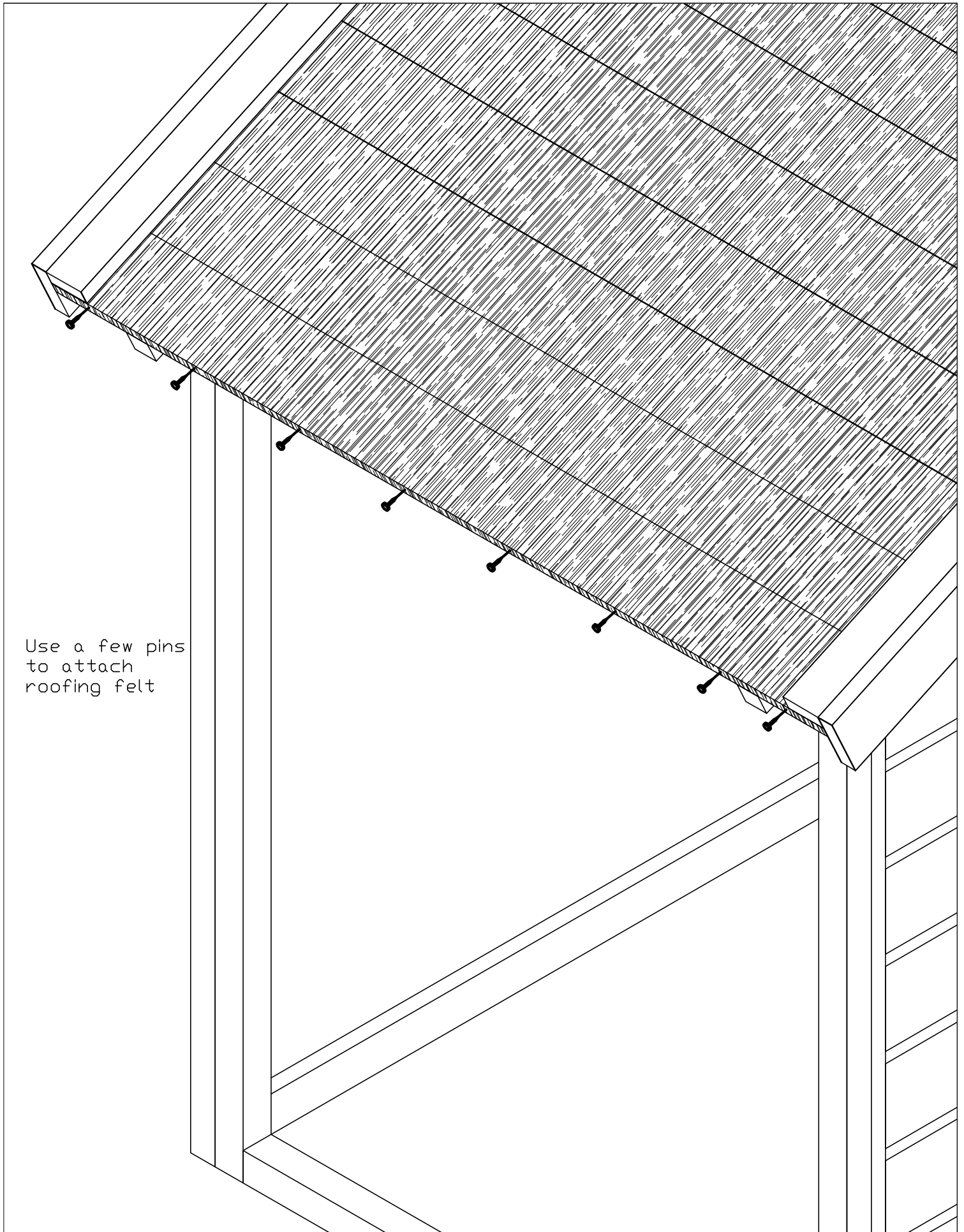

Use a few pins
to attach
roofing felt

Article:

Chicken coop Barnevelder

Article nr:

26.0061

Last modified:

05.03.2011

Page:

11/11